

Falcon 4M15

Area Scan Cameras



Key Features

- 4 megapixel resolution, 16 fps
- Global Shutter imaging
- Base Camera Link
- Single 11 V to 25 V power supply
- Partial scanning
- Robust and compact
- Excellent tap matching
- Color or monochrome models available

Programmability

- Area of Interest capability
- Selectable 8 or 10 bit digitization
- Programmable gain steps of 0.1 dB
- Programmable LUTs allow for gamma correction and improved output linearity
- Selectable 1 x 1, 2 x 2, or 4 x 4 binning

Typical Applications

- Electronics manufacturing inspection
- Industrial metrology
- Traffic management

Overview

Get the "bigger picture" with 4 megapixel resolution, high speed, and smear free imaging in this small, robust camera.

The Falcon 4M15 is our newest area scan camera for electronics manufacturing inspection, industrial metrology, and traffic management.

The camera uses a 4 megapixel (2048 x 2048) interline transfer sensor capable of running at up to 16 frames per second (higher with windowing) and features electronic global shuttering for smear-free imaging of fast-moving objects. These features allow for a large field of view, no smear effect, and high throughput.

The Falcon 4M15 offers programmable features and diagnostics accessible through the Camera Link™ MDR26 connector. The camera's small body and robustness make it perfect for the wear and tear of industrial environments.

Specifications

Resolution	2048 x 2048
Data Rate	2 x 40 MHz
Max. Line/Frame Rate	16 fps
Pixel Size	7.4 μm
Data Format	8, 10 bit
Output	Base Camera Link
Lens Mount	M42 x 1, C, F mount
Responsivity	22.9 DN/(nJ/cm ²) @ 530 nm
Dynamic Range	53 dB
Nominal Gain Range	0 to 15 dB
Size	56 mm x 56 mm x 56 mm
Mass	184 g
Operating Temp	0 °C to 40 °C
Power Supply	+11V to +25V
Power Dissipation	6 W @ 12 V / 7.1 W @ 24 V
Regulatory Compliance	CE
Control	MDR26 Camera Link
Data	Shared with Control
Power	Hirose 6 pin
Example Part Number	DS-21-04M15

Falcon 4M15

Area Scan Cameras

DALSA's Falcon cameras capture crisp images without smear or distortion by using short exposure times and electronically shuttering all pixels simultaneously.

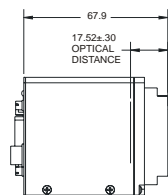
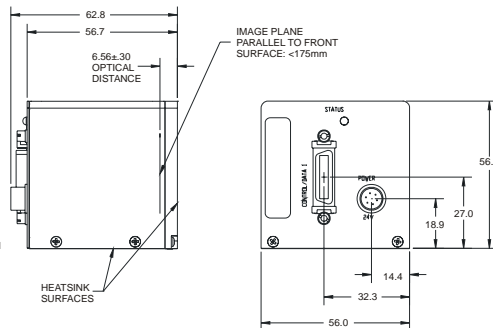
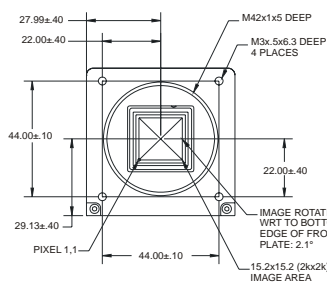
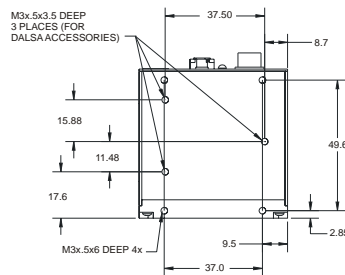
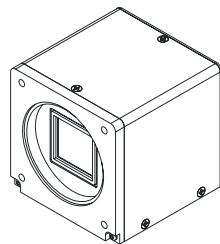
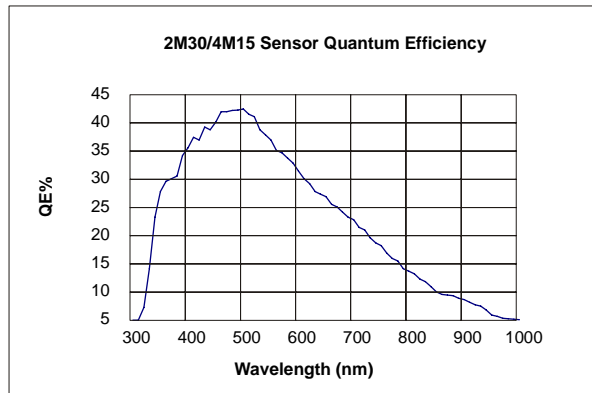

C- MOUNT CONFIGURATION

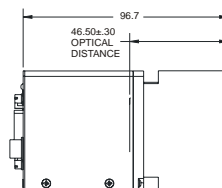

F- MOUNT CONFIGURATION